

PT250/PT251

Pressure Transmitters



Description

The PT250/PT251 series of pressure transmitters incorporate a stainless steel isolation diaphragm and all welded construction to withstand harsh industrial environments. Pressure ranges from 6 to 400 BAR or 100 to 5,000 PSI can be measured using a supply voltage of 9-32V. The transmitter provides a 4-20mA output proportional to applied pressure. The P250 is specified with pressure ranges measured in BAR while the PT251 pressure ranges are measured in PSI.

The rugged construction of the PT250 allows it to be used safely in environments with large over-pressure spikes. The 304L stainless steel diaphragm is compatible with most industrial fluids and gaseous media.

Features

- Welded Stainless Steel Construction
- Absolute or Sealed Gage References
- Packard, M12, 18mm & 9.4mm DIN Electrical Connectors
- 4–20 mA Output
- High Vibration Tolerance
- Superior EMI/RFI Rejection
- M10, M12, & M14 Pressure Ports
- Temperature Compensated



Applications

- Pumps & Compressors
- Process Controls
- HVAC & VAV
- Refrigerant Control & Recovery
- Water Management
- Autoclaves
- Hydraulic Systems
- Test & Monitoring Equipment

Standard Full Scale Pressure Ranges

6, 10, 16, 25, 40, 50, 100, 250, and 400 BAR (PT250)
100, 150, 200, 300, 500, 1,500, 3,000, 4,000, and 5,000 PSI (PT251)
Absolute or Sealed Gage

Technical Specifications

Note: Performance Specifications with 15 Vdc supply at 25°C

Pressure Ranges:	0–100 through 0–5,000 PSI 0–6 through 0–400 BAR Absolute or Sealed Gage	Total Error Band:	±2% of Span (-15°C to +85°C)
Proof Pressure:	2X	Response Time:	< 2ms
Burst Pressure:	250 BAR - (up to 50 BAR) 1,000 BAR - (above 50 BAR)	Operating Temperature:	-15°C to +85°C
Supply Voltage:	9-32 Vdc	Storage Temperature:	-40°C to +100°C
Current Output Span:	4-20 mA	Service Life:	1 Million Full Pressure Cycles
Load Resistance:	(Vs-9Vdc)/20mA	Vibration:	10G Sinusoidal from 10-2000 Hz
Linearity Error		Shock:	75G Sine Wave
Hysteresis and		Housing Material:	304L Stainless Steel
Repeatability:	±0.5%	Electrical Connector:	See "How to order"
		Pressure Connection:	See "How to Order"
		Reverse Polarity Protection:	32 V
		Maximum Voltage:	36 V



PT250/PT251

Pressure Transmitters

Outline Drawings

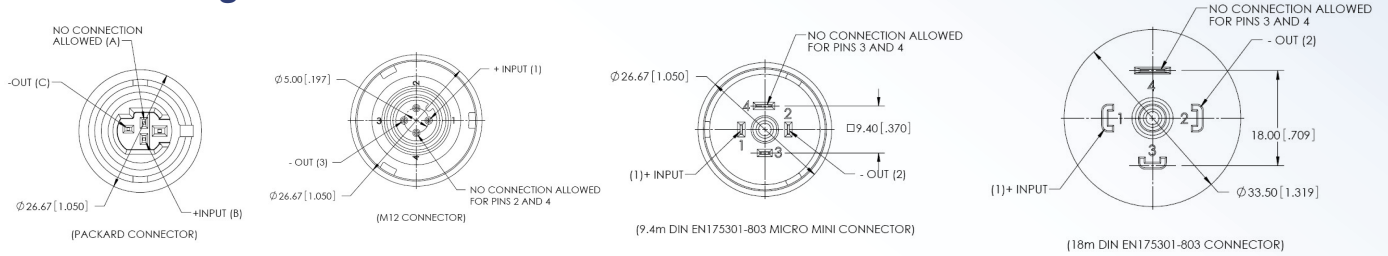

Dimension "A" = 15.8 mm (Max)
 "B" = 50.4 mm (Max)
 "C" = 18.8 mm

(Please consult factory for dimensions of specific configurations.)

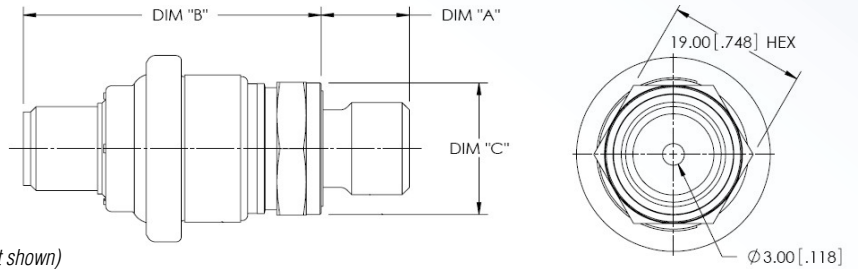

Mating Connectors: (Mating Connector Kits not shown)

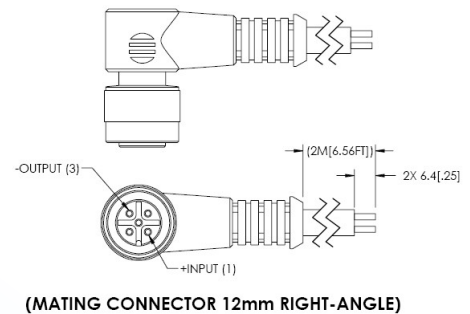
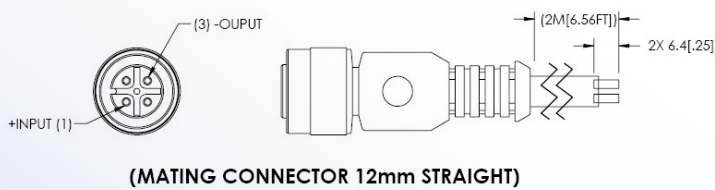
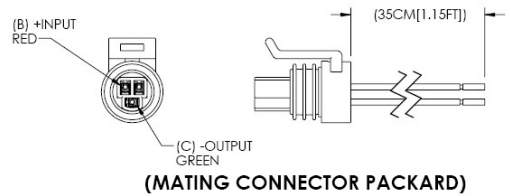
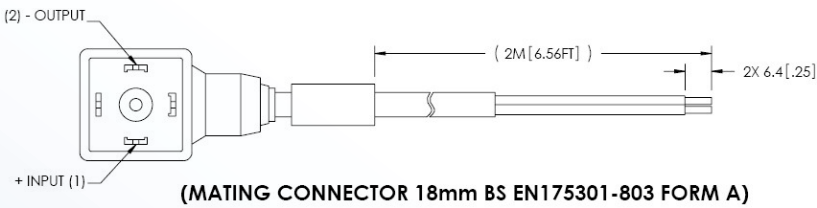
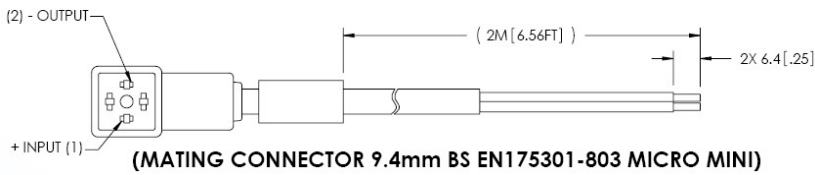

14501 Princeton Avenue | Moorpark, CA 93021
 Tel (805) 523-2000 | Fax (805) 523-7125
 Web: www.kavlico.com | E-Mail: sales@kavlico.com

PT250/PT251 Pressure Transmitters

How to Order

PT250 Pressure Transmitter		PT251 Pressure Transmitter	
Pressure Ranges			
6	0 – 6 BAR	100	0 – 100 PSI
10	0 – 10 BAR	150	0 – 150 PSI
16	0 – 16 BAR	200	0 – 200 PSI
25	0 – 25 BAR	300	0 – 300 PSI
40	0 – 40 BAR	500	0 – 500 PSI
50	0 – 50 BAR	1500	0 – 1,500 PSI
100	0 – 100 BAR	3000	0 – 3,000 PSI
250	0 – 250 BAR	4000	0 – 4,000 PSI
400	0 – 400 BAR	5000	0 – 5,000 PSI

Reference

- A Absolute
- S Sealed Gage

External Seal/Washer Material (Supplied for Straight Threads Only)

- B Nitrile Butadiene (NBR) (for Port 3 Option Only)
- D Fluorocarbon (FPM) (for Port 3 Option Only)
- G Aluminum Washer (Pressure Ports 6,7,8 and 9)
- X None

Pressure Connection (Port)

- 1 Stud End 1/4-18 NPT
- 2 Port 7/16-20 UNF-2A with Schrader Deflator (1/4" SAE Female Flare)
- 3 Stud End 7/16-20 UNF-2A, (SAE J1926-2)
- 4 Stud End 1/8-27 NPT
- 5 Port G1/4
- 6 Stud End G1/4
- 7 Stud End M10x1
- 8 Stud End M12x1.5
- 9 Stud End M14x1.5
- 10 Port M10x1.25 with Schrader Deflator
- 11 Stud End R1/4

Built-in Electrical Connector

- A Packard Connector with Mating Connector and 35cm Leads
- C Packard Connector
- D M12 with Mating Connector, Straight
- E M12 with Mating Connector, Right Angle
- F M12 Connector Kit Right Angle (without Wire)
- G M12 Connector Kit Straight (without Wire)
- H M12 (without Mating Connector)
- J 9.4mm, DIN EN 175301-803 Micro-mini (with Mating Connector)
- K 9.4mm, DIN EN 175301-803 Micro-mini
- L 18mm, DIN EN 175301-803 (with Mating Connector)
- M 18mm, DIN EN 175301-803 (w/o Mating Connector)

PT250 25 A X 1 A

Example: PT250-25A-X1A

Contact Kavlico for accuracy options, custom packaging, alternative pressure ranges, pressure connections or other OEM or application specific requirements.

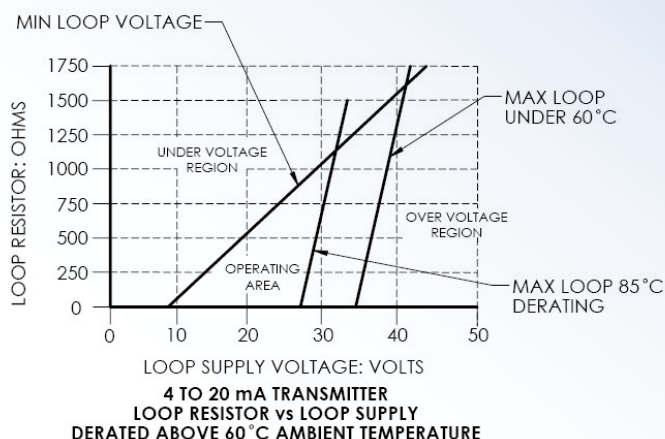

Although possible applications for our product(s) and other statements are presented herein, Kavlico is not expert in the user's technical field and therefore does not warrant the suitability of its product(s) for the user's applications. Therefore, Kavlico will not accept any liability and provides no guarantee, responsibility, or warranties of any kind concerning the suitability or related to the use of its product(s) for the user's applications.

Additionally, Kavlico will not be liable and provides no guarantee, responsibility, or warranties of any kind concerning the suitability or related to the use of its product(s) for the life support market or to be used in life support systems, safety or emergency systems, critical care applications, human implantation, aviation, nuclear facilities or systems or any other applications where product failure could lead to injury to persons, loss of life, harm to the environment, or catastrophic property damage.

Kavlico warrants that its products will be free from defective materials and workmanship for a period of one (1) year from date of delivery to the original purchaser and that its products will conform to Kavlico's specifications or standards. Any product found to be defective will be replaced or repaired at the sole option of Kavlico.

Note: Kavlico reserves the right to change its specifications at any time without notice. Kavlico is not an expert in the customer's technical field and therefore does not warrant the suitability of its product for the application selected by the customer.

Kavlico products are manufactured or covered by one or more of the following patents: 4,924,702; 4,967,071; 4,974,117; 5,020,377; 5,349,867; 5,415,036; 5,528,930; 5,540,086; 5,553,502; 5,576,251; 5,578,843; 5,656,780; 5,824,889; 5,923,952; 5,929,498; 5,929,754; 6,008,113; 6,041,658; 6,148,674; 6,178,829; 6,211,558 B1; 6,279,407; 6,297,733; 6,311,566; 6,404,184 B1; 6,495,388 B1; 6,505,398 B2; 6,564,642 B1; 6,581,468 B2; 6,583,631 B2; 6,584,853 B2; 6,605,904 B1; 6,683,464 B2; 7,334,489; 7,019,514; 7,162,926; 5,471,884; 6,145,383; 7,028,551; 7,028,552; 5,758,865; 6,911,819; 7,254,897; 7,251,997; 5,966,617; 6,849,807; 7,353,608; with other U.S. and foreign patents pending.



14501 Princeton Avenue | Moorpark, CA 93021

Tel (805) 523-2000 | Fax (805) 523-7125

Web: www.kavlico.com | E-Mail: sales@kavlico.com